

# ***TECHNICAL INFORMATION***

---

**CITIZEN QUARTZ**

**Cal. No. C350**

## Contents

<b>§1. OUTLINE</b> .....	1
<b>§2. SPECIFICATIONS</b> .....	1
<b>§3. EL (electroluminescence)</b> .....	2
A) Characteristics of EL panel .....	2
B) Effects of temperature and humidity on brightness of EL .....	2
<b>§4. HANDLING METHOD</b> .....	3
4-1. Name of Parts .....	3
4-2. Switching Modes (Functions) .....	3
4-3. Setting the Time and Calendar .....	4
4-4. Using the Alarm 1 [ALM 1] and Alarm 2 [ALM 2] .....	5
4-5. Using Chronograph [CHR] .....	6
4-6. Using Timer [TMR].....	7
4-7. All-Reset Operation.....	8
<b>§5. PRECAUTIONS FOR DISASSEMBLY AND ASSEMBLY</b> .....	8
<b>§6. DISASSEMBLY AND ASSEMBLY OF MOVEMENT</b> .....	9
<b>§7. TROUBLESHOOTING AND ADJUSTMENT METHOD</b> .....	11

## §1. OUTLINE

This combination watch has the functions of internal EL (Electroluminescence) to illuminate its dial in a dark place, alarm, chronograph and timer.

## §2. SPECIFICATIONS

Caliber No.		<b>C350</b>
Type		Combination (Analog + Digital) quartz watch
Module size		27.0 x 27.4 x ø30.8 x 5.1t
Accuracy (At normal temperature)		±30 sec/month
IC		C/MOS-LSI, 1 unit
Operation temperature range		0°C ~ +55°C (32°F ~ 131°F)
Time adjustment		Impossible (No terminals for adjustment in the market)
Measurement gate		2 sec
Indicating functions	Analog	Time: Hour, minute
	Digital	Time: (AM/PM) Hour, minute, second Calendar: Month, date, day Alarm: Hour, minute, ON/OFF Chronograph: Less than 60 minutes: Minute, second, 1/100 second 60 minutes and over: Hour, minute, second Timer: Minute, second, set time
Additional function		<ul style="list-style-type: none"> <li>• EL illumination</li> <li>• Alarm I, II</li> <li>• Chronograph: 24-hour measurement (In: 1/100 seconds), split time measurement</li> <li>• Timer: 99-minute measurement (In: 1 second), automatic chronograph function, forecast sound (Can be turned on/off)</li> </ul>
Battery	Part No.	280-44
	Battery No.	SR927W
	Normal voltage	1.55V
	Normal capacity	60mAH
	Life	Approx. 2 years (When EL is turned on for 3 sec/day and alarm for 40 sec/day)
Remarks		

### **§3. EL (Electroluminescence)**

#### **A) Characteristics of EL panel**

The EL is used as the EL panel in the watch. This EL panel has the following characteristics.

- 1) If the source voltage lowers, the brightness lowers.
- 2) As the illuminating time is increased, the brightness lowers.
  - \* The brightness of the EL panel reduced to the half when its integrated illuminating time reaches several hundred hours.
- 3) If the EL panel is turned on, the consumed currents is increased to several mA.

#### **B) Effects of temperature and humidity on brightness of EL**

##### **1) Effects of temperature**

The brightness changes little at a high temperature (40°C/104°F). If the temperature lowers (0°C/32°F), the brightness lowers a little since the source voltage lowers.

##### **2) Effects of humidity**

Humidity has little effects on the brightness of the EL panel installed in the watch.

- If moisture enters the watch, the brightness of the EL panel may lower or it does not illuminate at all.

Water resistance trouble .....If water enters the watch, it can damage the EL panel. If it is dried, its functions can be restored to a certain degree. The cause of the water resistance trouble must be remove first, in this case.

Handling of EL panel unit .....If the EL panel is exposed to dampness for long hours, it is deteriorated. Do not store the EL panel for a long time. If it is obliged to keep it, store it in a dry and dark place.

## §4. HANDLING METHOD

### 4-1. Name of Parts

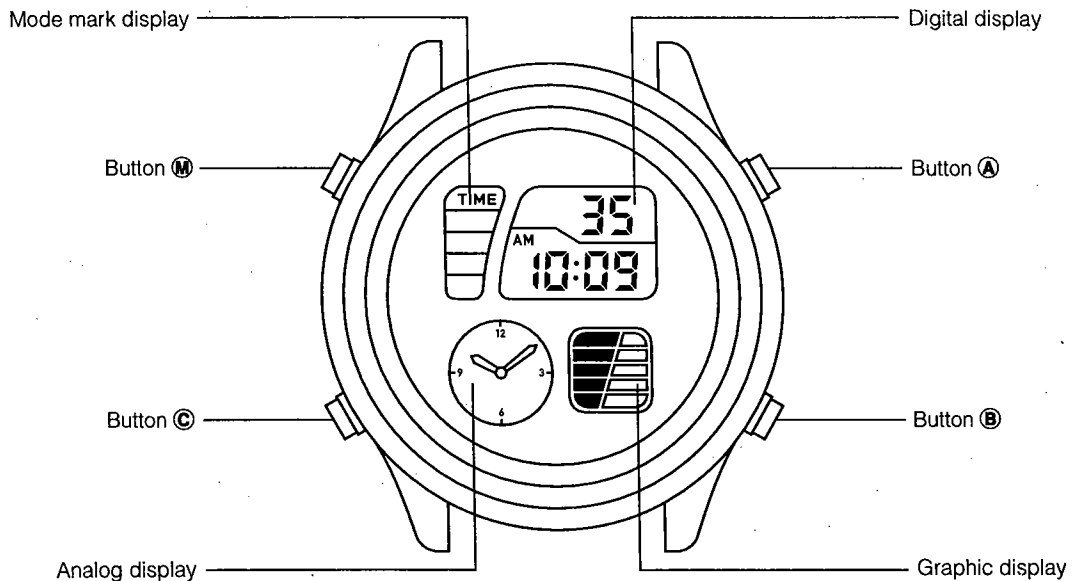

#### How to turn on EL

- Push the **A** button in any mode, and EL will be turned on.

### 4-2. Switching Modes (Functions)

In addition to the time/calendar mode, the watch has four modes: Alarm 1, Alarm 2, Chronograph, and Timer. Each time button **M** is pressed, the mode display is switched in the following order: [TIME] → [ALM 1] → [ALM 2] → [CHR] → [TMR].

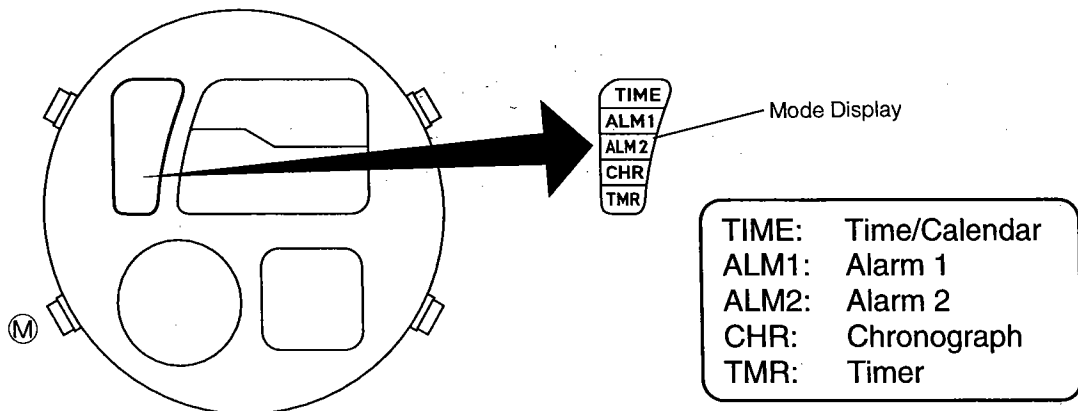

#### Note:

If the watch is left in the ALM 1 or ALM 2 mode for 2 to 3 minutes, the display automatically returns to the TIME mode.

## 4-3. Setting the Time and Calendar

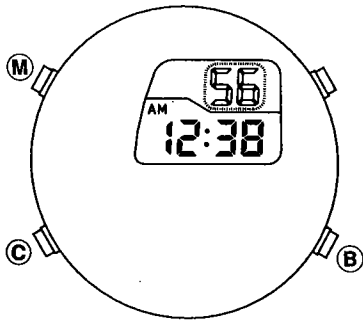

### A. Digital setting

- 1) While in the time mode, press button **(C)** for one second or more, seconds will flash and switch to correcting state.
- 2) While seconds flash, press button **(B)** to reset the seconds to "00" after that seconds start again.
- 3) When in the seconds correcting state (second flash), press button **(C)**, the flashing digit will change in the order of seconds → minutes → hours → month → date → day → 12/24 hour → (Analog time setting) system. Select the digit to correct.
- 4) Correct the flashing digit by pressing button **(B)**.
- 5) Press button **(C)** or **(M)** to complete setting.

Press button **(B)**, the time and Calendar display will switch alternately.

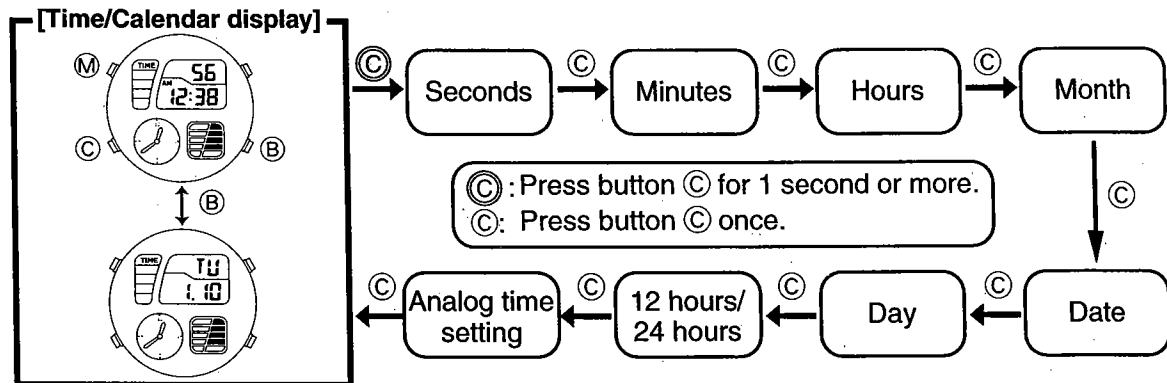

- Press button **(B)**, the 12 hour/24 hour will switch alternately.
- If the time correct state (flashing digit) remains for longer than 2 to 3 minutes, the watch will automatically return to normal time display mode.
- Press button **(M)** while in the time correct state, can be return the watch to normal display mode. (Manual return)
- Due to the auto-calendar, no correcting at the end of the month is required.

### B. Analog time setting

The Analog time settings are electromagnetic correction system.

- 1) While in the time correct state, select the mode to Analog time setting (A-SET display and all digital digit flashing) by pressing button **(C)**.
- 2) Set the hour/minute hand to the desired time by pressing button **(B)**.
  - Press button **(B)** each time, hands will move one minute increment.
  - Press button **(B)** continuously, hands will move quick advance.

#### 4-4. Using the Alarm 1 [ALM 1] or Alarm 2 [ALM 2]

Operating the Alarm 1 and Alarm 2 are same, only alarm sound different.

When the alarm indicator is ON, the alarm will sound for 20 seconds at the alarm set time, once a day.

##### [Normal alarm (ON) display]

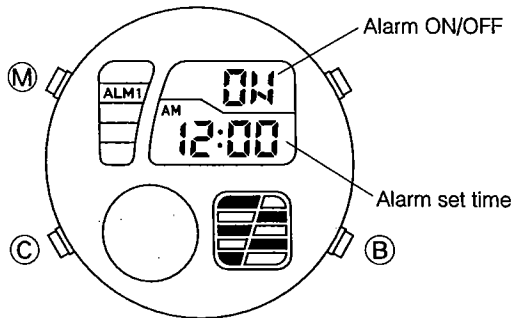

##### [Setting the alarm]

- 1) While in the alarm mode, press button **C**, the hour will start flash and alarm will indicate ON automatically.
- 2) While hour flashes, press button **B** to set the hours.
- 3) Press button **C**, the flashing digit will change in this order: hours → minutes.
- 4) While minutes flashes, press button **B** to set the minutes.
- 5) Press button **C** or **M** to finalize setting.
  - \* Press and hold down button **B** to quick advance the flashing digit.
  - \* Alarm 12 hours/24 hours is set in synchronized with the time/calendar mode.

##### [Stop the alarm sound]

Press any button to stop the alarm sound.

##### [Alarm ON/OFF]

Switch the alarm ON/OFF by pressing button **B**.

##### [Alarm monitor]

In the alarm mode, while pressing button **B**, the alarm monitor will sound.

## 4-5. Using Chronograph [CHR]

- This chronograph can measure up to 24 hours in 1/100 seconds.
- The chronograph display automatically returns to 00 and stops after 24 hours measurement.

### [Chronograph timing display]

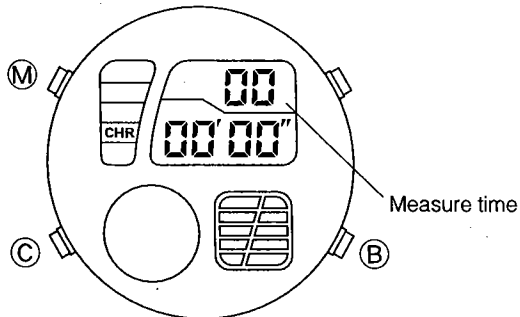

#### <Up to 59 minutes 59.99 seconds>

Minutes, seconds, 1/100 seconds display

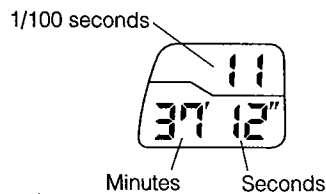

#### <1 hour over>

Hours, minutes, seconds display

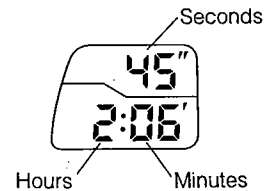

### [Using the chronograph]

#### <Standard measurement>

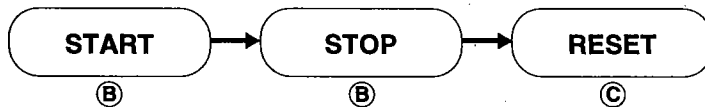

#### <Accumulated elapsed time measurement>

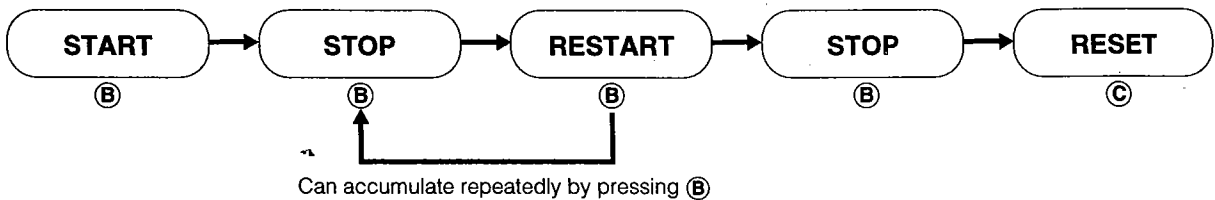

#### <Split time measurement>

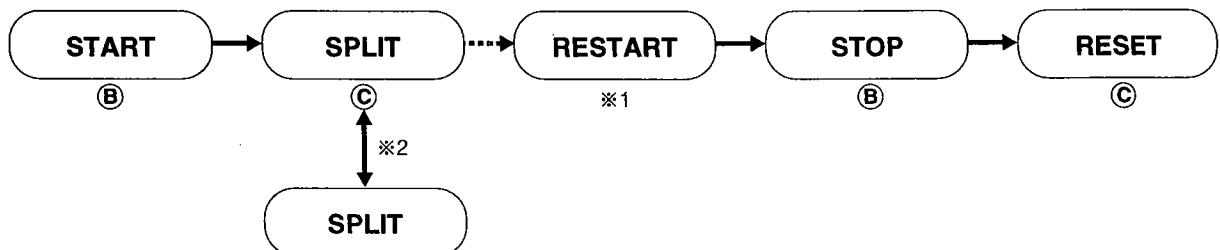

\*1 Automatically switched after 10 seconds.

\*2 When the same button C is pressed again during the display of a split time, the next split time is displayed.



## 4-6. Using Timer [TMR]

- The timer can be set up to 99 minutes in 1 minute.
- The timer automatically switched to chronograph measurement when the timer time is up.
- A warning sound before the set time is up and sound beep when the time is up.

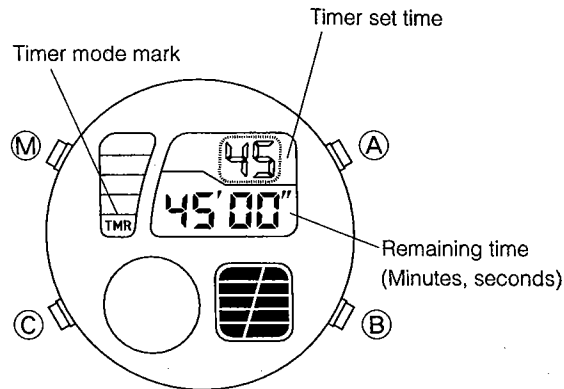

### [Setting timer]

- Press button **(C)** to advance one minute at a time.  
\* Press button **(C)** continuously, minutes will move quick advance.

### [Timer start/stop]

- Press button **(B)** to start the timer after the timer is set.  
A start beep sounds once at this time.
- Press button **(B)** at any time the timer is in motion to stop the timer. Press button **(B)** again to restart the timer.
- Press button **(C)** to reset the timer while the timer is stopped.

### [Timer time up and auto-chronograph feature]

- At the end of a timing session, an end of session confirmation beep sounds for 5 seconds, the watch switches to the chronograph measurement starts. (Auto-chronograph feature)

#### ☆ Auto-chronograph feature

The auto-chronograph feature can measure up to 24 hours in 1 second start from timer time up.

- Press button **(B)** to stop measurement.
- Press button **(B)** again to repeat the start and stop cycle.
- Press button **(C)** to reset chronograph.
- \* This auto-chronograph can not use to split time measurement.

### [A time up warning beep sounds ON/OFF feature]

Can be switched ON or OFF of a time up warning beep sounds by press button **(B)** during pressing button **(A)**.

When switch to ON, timer mode mark will flash.

A time up warning beep sounds once at the following intervals: before the time is up 5, 4, 3, 2, 1 minutes and every 10 seconds from 50 to 10, 9, 8, .....5, 4, 3, 2, 1.

#### ☆ Fly back feature

The fly back feature is used to restart the timer anytime after the timer has already been started.

Press button **(C)** anytime during a timer counting, a confirmation beep will sound and the timer restart the moment.

## 4-7. All-Reset Operation

After replacing the battery or when the watch's display is unusual due to strong shock or intense static electricity. (No display, alarm continuously sounds etc.)

Perform the all-reset operation as follows:

- (1) Press buttons **(A)**, **(B)**, **(C)**, and **(M)** simultaneously.
- (2) Release the buttons. All the display segments will appear.
- (3) Press any button of **(A)**, **(B)**, **(C)**, or **(M)**. At that time confirmation will sound.

The all-reset operation is complete. Setting each mode again before using.

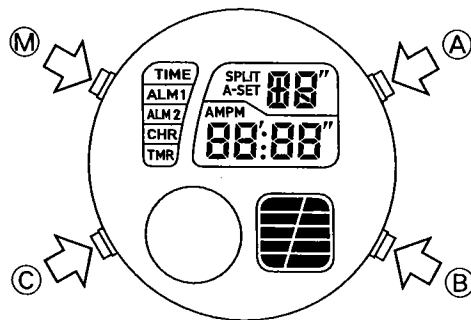

## §5. PRECAUTIONS FOR DISASSEMBLY AND ASSEMBLY

### How to Remove Circuit Unit Supporter

- Remove the screw first, then remove the four hooks of the circuit unit supporter.
  - \* Take care not to deform the hooks and switch of the circuit unit supporter.

### How to Mount LCD Panel Holder

- Slide the LCD panel holder under the circuit unit supporter from the 3-o'clock side, then tighten the set screw.
  - \* When mounting the LCD panel holder, take care not to crack the LCD panel and not to tighten the set screw too strongly.

## §6. DISASSEMBLY AND ASSEMBLY OF MOVEMENT

Disassembly procedure: ① → ⑳

Assembly procedure: ㉓ → ①

● Lubrication mark

Ⓐ : A-Lube oil

Ⓥ : V-Lube oil

ⓕ : F-Lube oil

Ⓞ : CH-1 oil

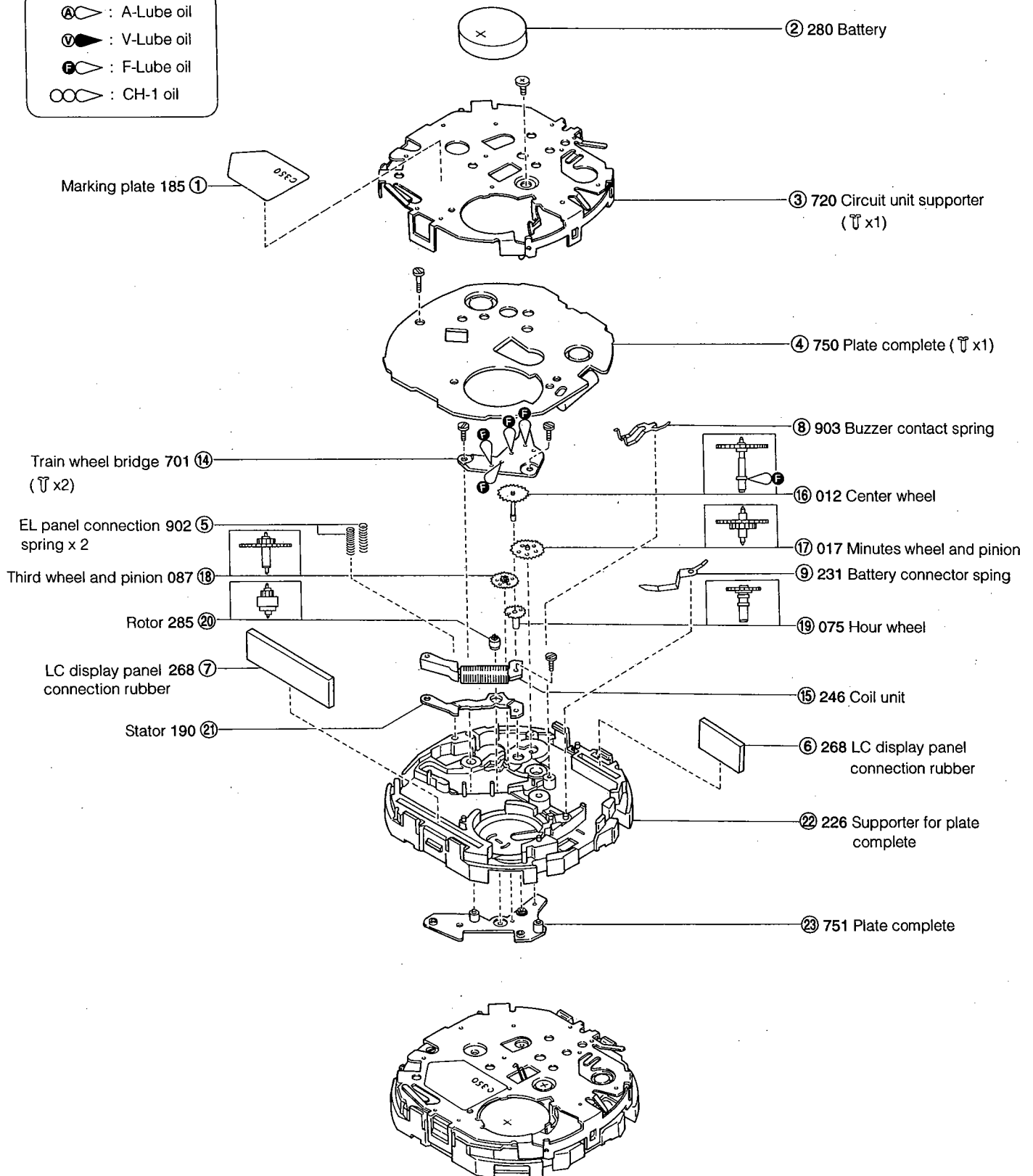

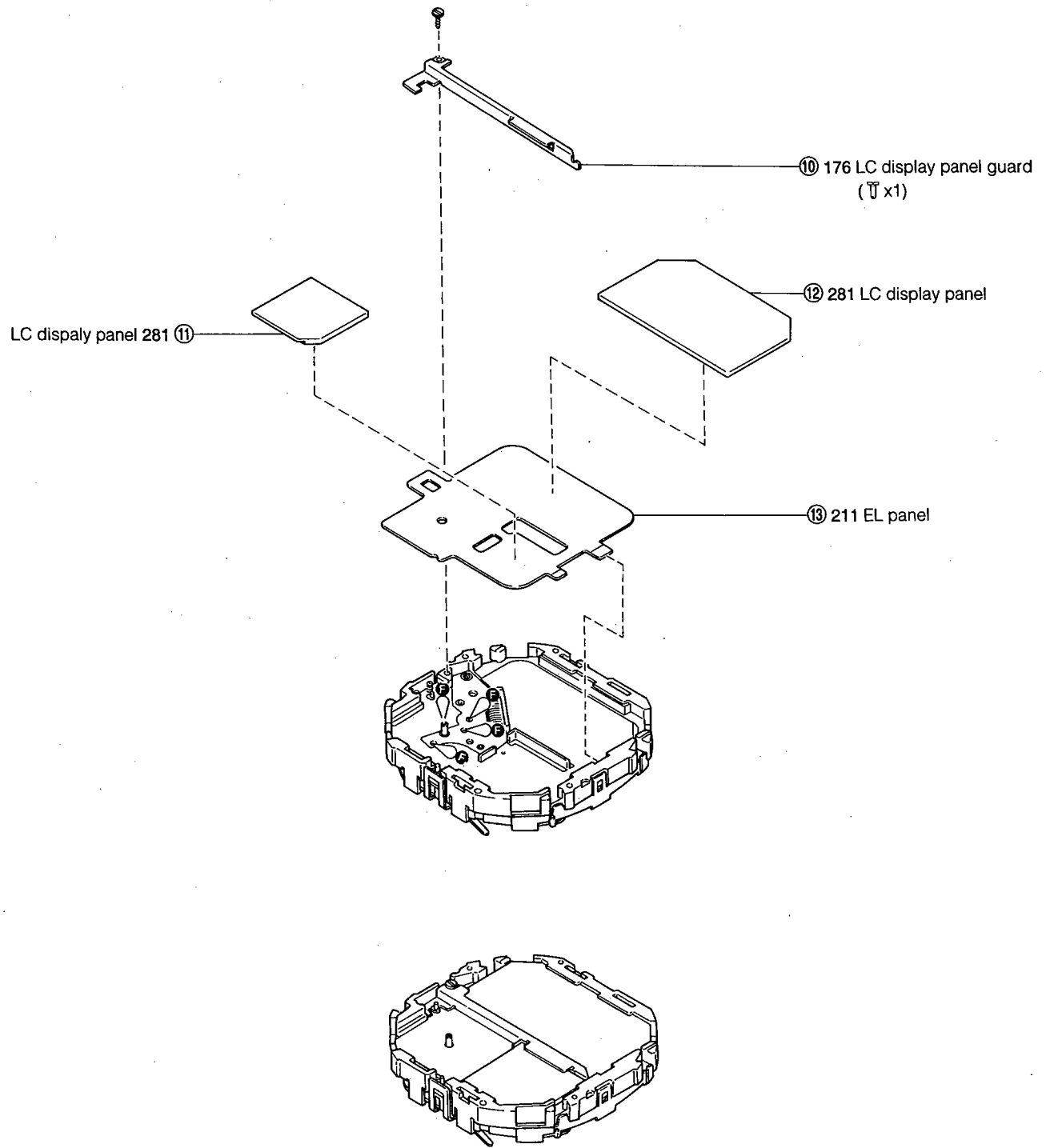

# §7. TROUBLESHOOTING AND ADJUSTMENT METHOD

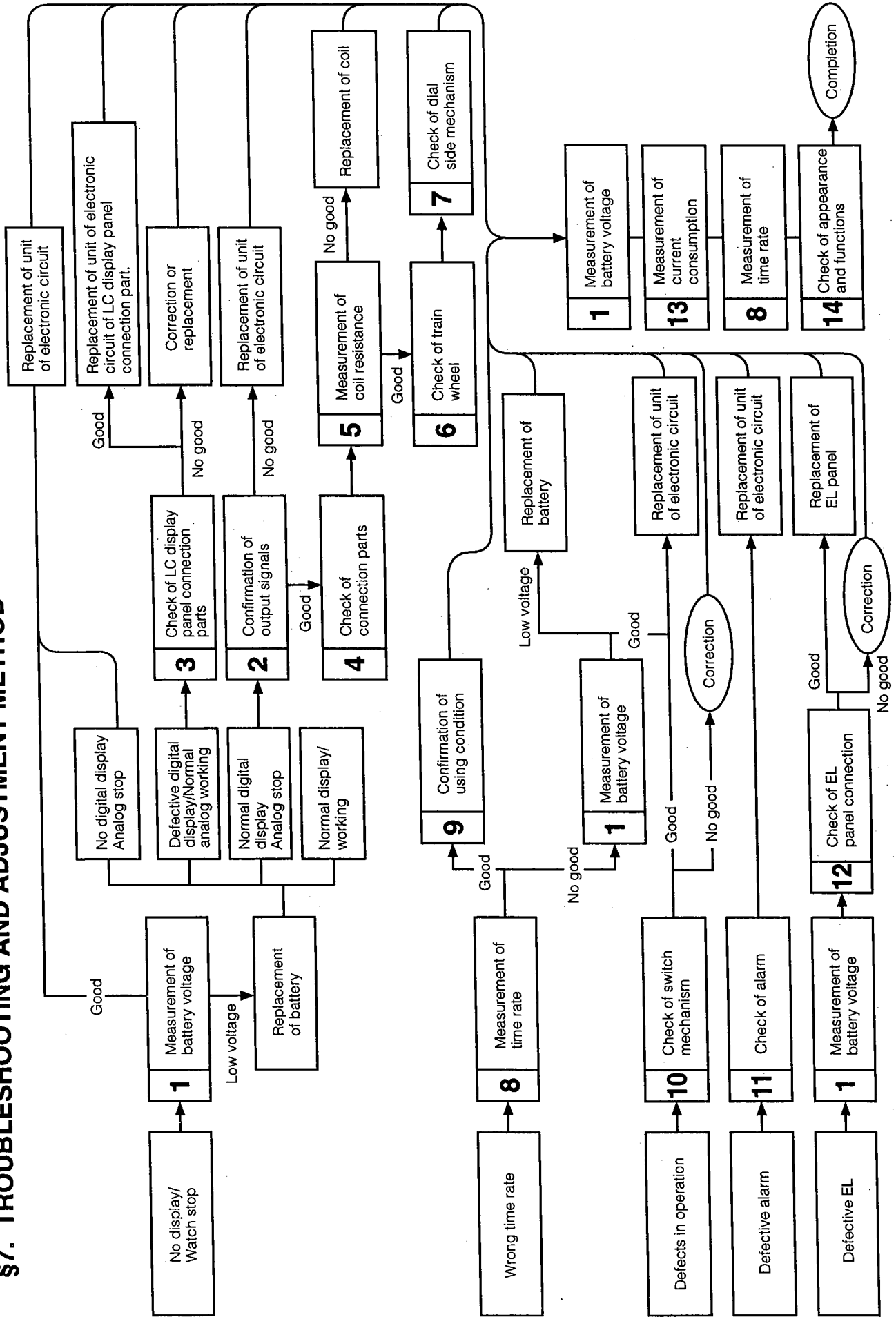

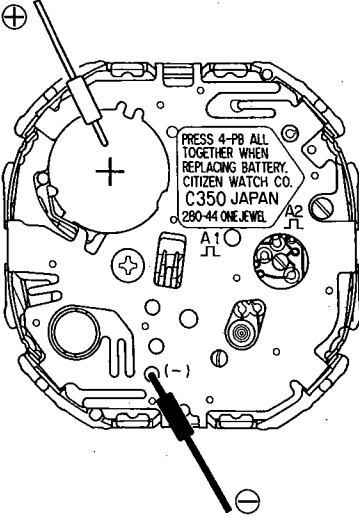
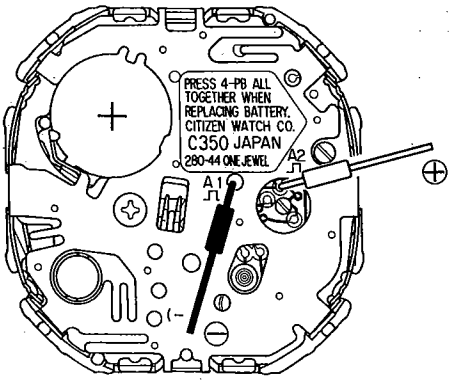
Check Items	How to Check	Result and Treatment
<p>① Measurement of battery voltage</p>	<p>&lt;Refer to Technical Manual, Basic Course: II-1-a&gt;</p> <ul style="list-style-type: none"> <li>Apply the ⊕ test lead pin to the top of the battery and the ⊖ one to the mark of ⊖ (Pattern of ⊖) on the circuit unit supporter.</li> </ul> <p style="text-align: right;">&lt;Tester range: D.C. 3V&gt;</p> 	<ul style="list-style-type: none"> <li><b>Over 1.5V</b> → Nondefective.</li> <li><b>Under 1.5V</b> → Replace the battery.</li> </ul>
<p>② Confirmation of output signal</p>	<p>&lt;Refer to Technical Manual, Basic Course: II-1-b&gt;</p> <p style="text-align: right;">&lt;Tester range: D.C. 3V&gt;</p>  <p>(The tester lead pins have no polarity)</p> <ul style="list-style-type: none"> <li>Since the analog unit of this watch is operated at the interval of 1 minute, the tester pointer swings once a minute.</li> </ul>	<ul style="list-style-type: none"> <li><b>Tester pointer does not swing.</b> → Check connections.</li> <li><b>Tester pointer swings to left and right per minute.</b> → Replace the electronic circuit unit.</li> </ul>

Check Items	How to Check	Result and Treatment
<p>③ Check of LC display panel connection parts</p>	<p>&lt;Refer to Technical Manual, Basic Course: II-2-a, Digital section&gt;</p> <ul style="list-style-type: none"> <li>● <b>Check of all segments</b> Perform the all-reset operation for check. Push the (A), (B), (C) and (M) button simultaneously, and the all segments are turned on. Check the parts for stain and breakage.</li> <li>● Inspect the continuity of the LCD panel, LCD connecting rubber and electronic circuit unit, and check them for stain. Check the parts for stain and breakage.</li> </ul>	<ul style="list-style-type: none"> <li>● The LC display panel, its connection rubber or plate complete is not installed normally → Re-install.</li> <li>● There is dirt or stain → Remove dirt and stain.</li> <li>● A part is cut, broken or scratched → Parts defective.</li> </ul>
<p>④ Check of connection part</p>	<p>&lt;Refer to Technical Manual, Basic Course: II-2-a, Analog section&gt;</p>	
<p>⑤ Measurement of coil resistance</p>	<p>&lt;Refer to Technical Manual, Basic Course: II-1-c&gt;</p> <ul style="list-style-type: none"> <li>● Remove the electronic circuit to measure the coil resistance.</li> <li>● The tester lead pins have no polarity.</li> </ul> <p style="text-align: right;">&lt;Tester range: R x 10&gt;</p>	<ul style="list-style-type: none"> <li>● 1.9 ~ 2.5kΩ → Nondefective</li> <li>● Out of above range → Replacement coil unit.</li> </ul>
<p>⑥ Check of train wheel</p>	<p>&lt;Refer to Technical Manual, Basic Course: II-2-b&gt;</p>	

Check Items	How to Check	Result and Treatment
<p>⑦ Check of dial side mechanism</p>	<p>&lt;Refer to Technical Manual, Basic Course: II-2-c&gt;</p>	
<p>⑧ Measurement of time rate</p>	<p>&lt;Refer to Technical Manual, Basic Course: II-2-d&gt; (Measurement gate: Digital, 2 sec) The accuracy of this watch is <math>\pm 30</math> sec/month (<math>\pm 1</math> sec/day). Since this watch does not have a trimmer capacitor, its time rate cannot be adjusted.</p>	<ul style="list-style-type: none"> <li>• This time gains or loses largely. → Replace the electronic circuit unit.</li> </ul>
<p>⑨ Confirmation of using condition</p>	<p>&lt;Refer to Technical Manual, Basic Course: II-2-e&gt;</p>	
<p>⑩ Check of switch mechanism</p>	<p>① Check of movement</p> <ul style="list-style-type: none"> <li>• Push the switch return spring of the circuit unit supporter with tweezers, etc. to bring it contact with the pattern of the plate complete to confirm the switching function.</li> </ul> <p>② Check of push buttons</p> <ul style="list-style-type: none"> <li>• Check the push buttons for deformation and dirt.</li> </ul> <div style="border: 1px solid black; border-radius: 10px; padding: 5px; margin-top: 10px;"> <p><b>Note:</b> Apply silicone oil to the packings of the push buttons without fail. It is necessary for maintenance of water resistance and smooth operation.</p> </div>	<ul style="list-style-type: none"> <li>• No problems in switch mechanism → Check the push buttons.</li> <li>• The pattern is removed or deformed → Replace defective parts.</li> <li>• Any push button is dirty or deformed → Clean or replace the push button.</li> </ul>

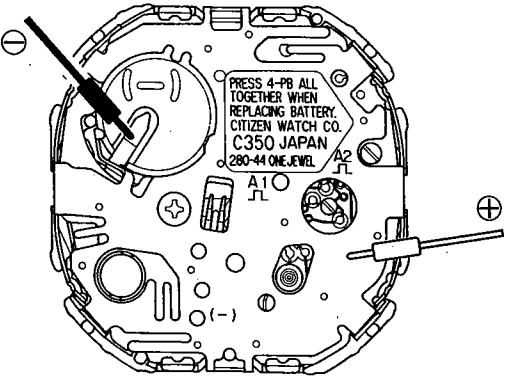

Check Items	How to Check	Result and Treatment
<p>⑪ Check of alarm</p>	<p>&lt;Refer to Technical Manual, Basic Course: II-1-d&gt;</p> <p>1. With the movement in the case, check the output of the alarm.</p> <p>(1) Set the watch in the alarm motor (ALM 1 or ALM 2).</p> <p>(2) Apply the positive ⊕ test lead pin to the top of the battery, and the negative one ⊖ to the buzzer contact spring.</p> <p>(3) With the test lead pins applied, push the Ⓑ button.</p> <p style="text-align: right;">&lt;Tester range: D.C. 0.3V&gt;</p> <p>2. If the alarm output is normal, perform the following inspection.</p> <ul style="list-style-type: none"> <li>• Check the piezo-electric element on the case back for cracking and breakage.</li> <li>• Check the buzzer contact spring for bend and deformation.</li> <li>• Check the electronic circuit unit for dust and stain.</li> </ul>	<ul style="list-style-type: none"> <li>• Tester pointer does not swing → Replace the electronic circuit unit.</li> <li>• Tester pointer swings → Normal.</li> </ul> <p style="text-align: center;">↓</p> <p>Perform the inspection in 2.</p> <p style="text-align: center;">If normal, OK</p>
<p>⑫ Check of connections of EL panel</p>	<p>1. Check of battery voltage</p> <p>2. Check of connections of EL panel</p> <ul style="list-style-type: none"> <li>• Check the EL panel for breakage. Check for continuity trouble caused by stain, breakage, ect. of the electrode pattern on the back side.</li> <li>• Confirm that the EL connection spring is in contact with the electrobe pattern of the EL panel.</li> </ul> <p>If any defect is not found by the above inspections 1 and 2, the EL panel must be deteriorated. Replace the EL panel.</p>	<ul style="list-style-type: none"> <li>• <b>Over 1.5V</b> → Check connections of the EL panel.</li> <li>• <b>Under 1.5V</b> → Replace the battery.</li> <li>• The EL panel is defective → Replace the EL panel.</li> <li>• The EL connection spring is deformed → Correct or replace.</li> </ul>

Check Items	How to Check	Result and Treatment
<p>⑬ Measurement of current consumption</p>	<p>&lt;Refer to Technical Manual, Basic Course: II-1-f&gt;</p> <p>Measure the current consumption according to the following procedure</p> <ul style="list-style-type: none"> <li>• Measure the current consumption in the ALM mode with the power turned off.</li> </ul> <p>① Set the tester.</p> <p>② Set the tester to the 10-mA range.</p>  <p>③ With the test lead pins applied, push the (A), (B), (C) and (M) buttons simultaneously, then push any one of them (All-reset operation).</p> <p>④ Push the (M) button once to set the watch to the ALM mode (OF).</p> <p>⑤ After the tester pointer is stabilized, change the tester to the 10-<math>\mu</math>A range.</p> <p>⑥ After the tester pointer is stabilized, it indicates the power consumption.</p> <p>☆ <b>Precautions for measurement</b></p> <ol style="list-style-type: none"> <li>1. Be sure to measure according to the above procedure. If this procedure is not observed, an abnormal value may be indicated and the watch may operate abnormally and the current consumption cannot be measured normally.</li> <li>2. When the test lead pins are applied to the measuring points, the meter pointer may exceed the maximum value, but this does not indicate a trouble. In this case, continue measurement for 30 sec and wait until the pointer is stabilized.</li> </ol> <p><b>Effects of light</b></p> <p>Do not measure the current consumption in a place where the watch is exposed to the light of an incandescent lamp or the sun. If it is measured in such place, more current may be consumed. The current consumption is not affected by the light of a fluorescent lamp.</p>	<ul style="list-style-type: none"> <li>• The current consumed by movement (ALM 1 mode) is <b>Under 1.8<math>\mu</math>A</b> → Normal</li> <li>• <b>Over 1.8<math>\mu</math>A</b> → Replace electronic circuit unit.</li> </ul>
<p>⑭ Check of appearance and functions</p>	<p>&lt;Refer to Technical Manual, Basic Course: II-2-f&gt;</p>	